

変更 REVISIONS			
回数 REV. MARK	日付 DATE	記事 CONTENTS	変更者 REVISED BY

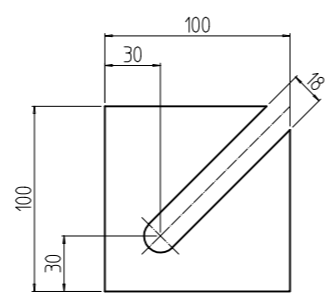
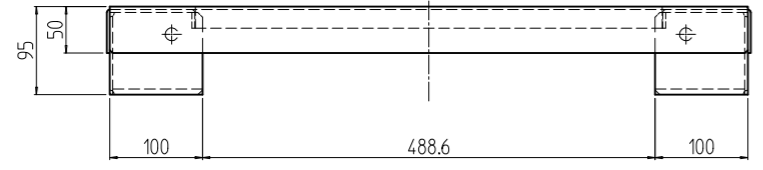
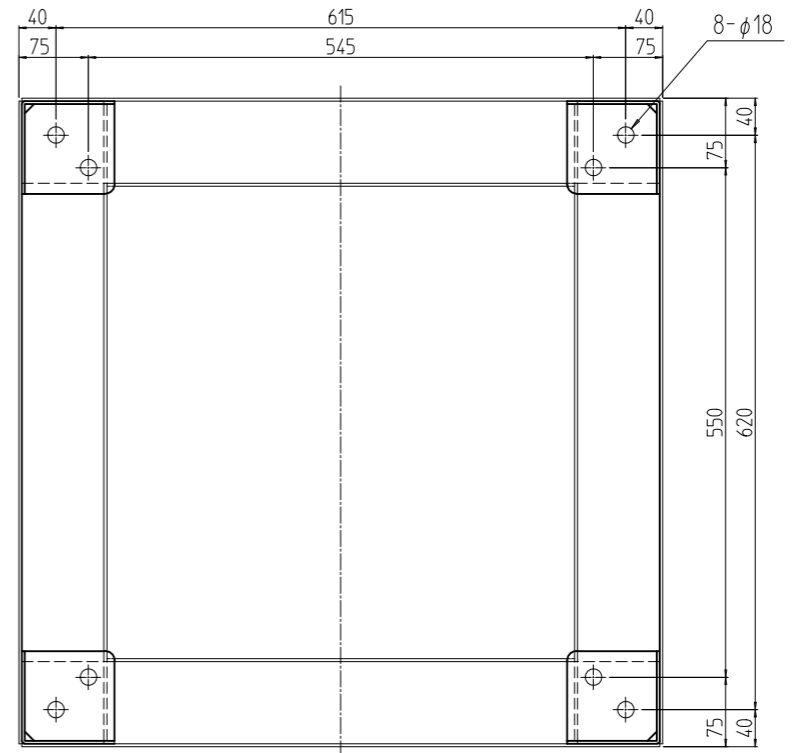
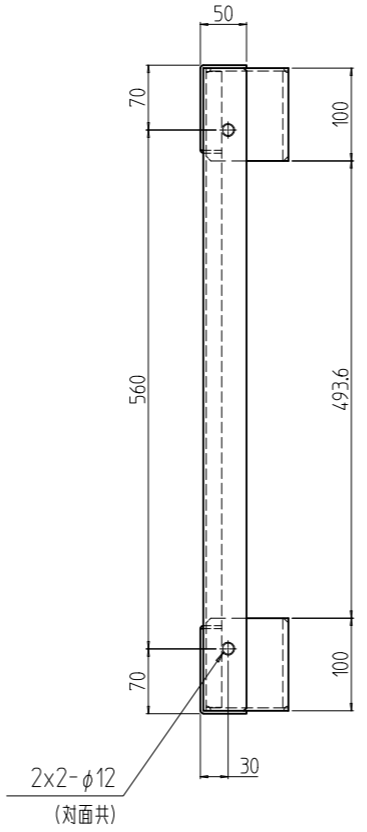
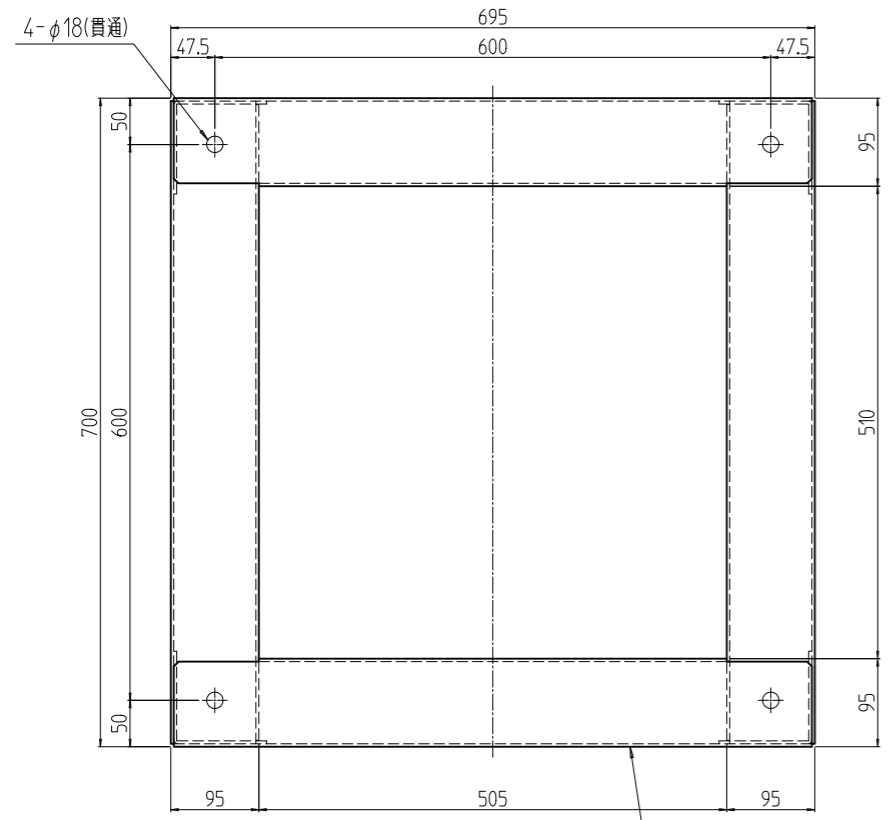

架台用ライナー外観寸法 (1 : 4)

ゴムスペーサー詳細

2	04		ゴムスペーサー 510	CRゴム65° t3.0	「ブラック」片面接着テープ貼付
8	03		架台用ライナー-3.2	鋼板 t3.2	「ブラック」メラミン塗装
8	02		架台用ライナー-1.2	鋼板 t1.2	
1	01		SSO板金架台 701070	鋼板 t3.2/SPHC t6.0	
個数 QUANTITY	No.	図番 DRAWING No.	部品名 PART NAME	材質 MATERIAL	仕上 FINISH
		単位 UNIT	設計 DESIGNED	検 CHECKED	承認 APPROVED
		mm			
SSO-701070PB2	型式 MODEL	出	図名 TITLE		
		1 : 8	品名 NAME		
			SSO架台		
			型式 MODEL		
			SSO-701070PB2		
			図番 DRAWING No.		
			SSO-561511		

SETTSU 摂津金属工業株式会社